

ACCESSORIES

Car Adapter

Enables you to re-charge your battery with your vehicle's electrical system.



Part No. 900507

Battery Cell



Part No. 018880

Battery Charger

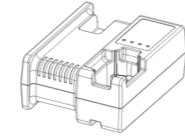

Part No. 018882 (UK)

Cable

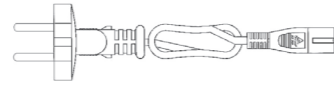

Part No. 018886 (UK)

Hex Key



Part No. 401331

Safety Glasses



Part No. 014121

Paslode Intensive Tool Cleaner 300 ml

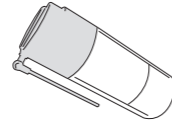

Part No. 115251

Paslode Impulse Lubricating Oil

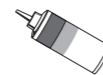

Part No. 013075

Carrying Case Standard



Part No. 014016

Specific Probes

Part No. 019783

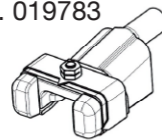

Part No. 019784

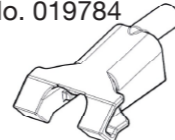

Part No. 019785

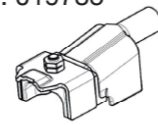

Standard magazine

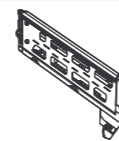

Part No. 019766

Cleaning Kit (Blister)

Contains all the necessary to clean any Impulse tool



Part No. 013690

Maintenance Kit

(Filter + o'ring)



Part No. 013231



Part No. 019700 (UK)



360Xi

IMPORTANT! DO NOT DESTROY

Always refer to operating and safety instructions (019693&019803UKCA) for detailed information on this tool. It is the customer's responsibility to have all operators and service personnel read and understand this information.

TOOL SCHEMATIC AND PARTS



An Illinois Tool Works Company
150, Route de Lyon
F - 26500 Bourg-lès-Valence - France

019698-03 10/24

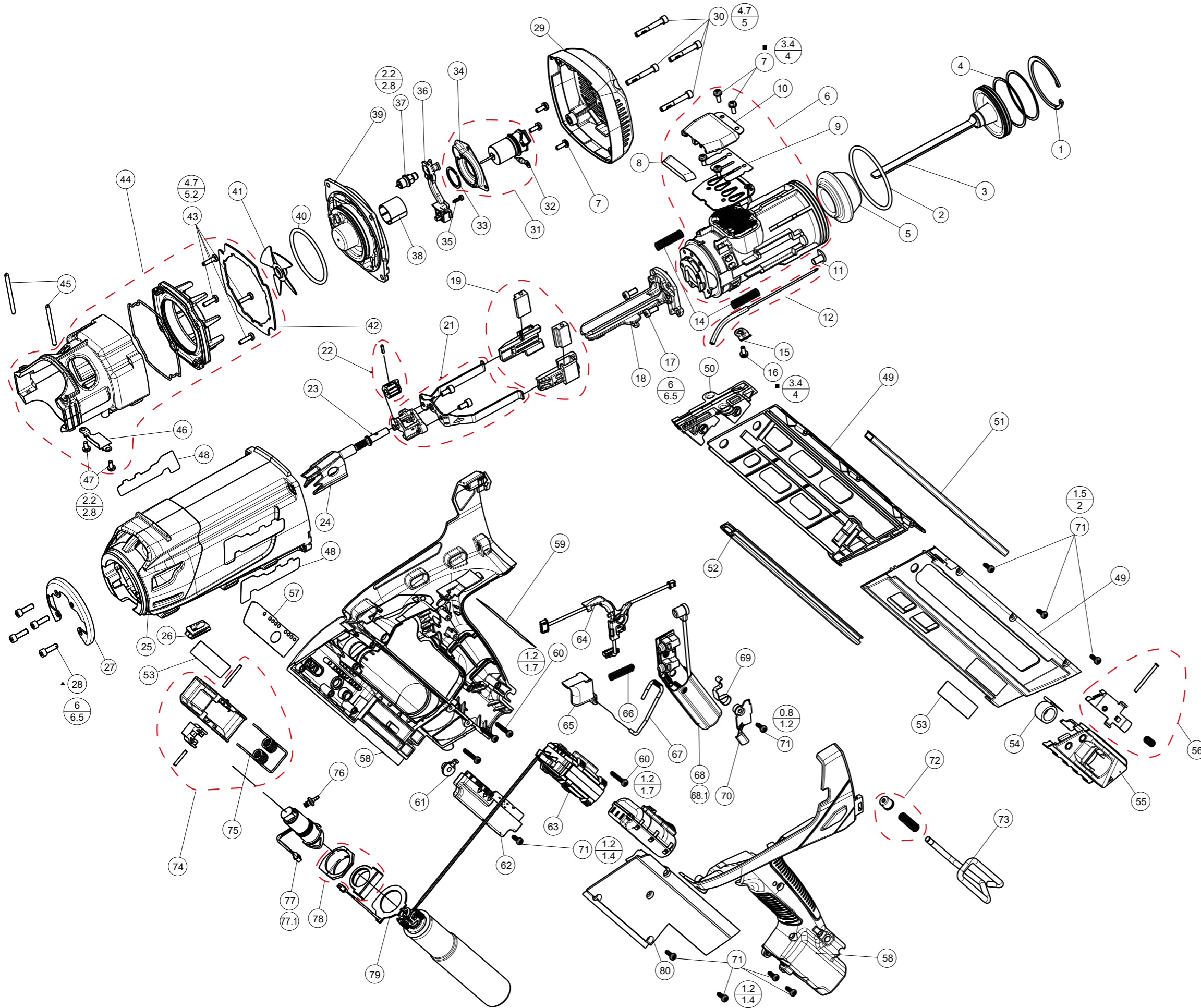

REP	CODE	QUANTITY	DESCRIPTION
1	336680	1	RETAINER RING
2	013743	1	CYLINDER O'RING
3	019296	1	PISTON ASSEMBLY
4	336670	2	PISTON RING
5	013778	1	BUMPER
6	019292	1	CYLINDER ASSEMBLY
7	900596	5	SCREW SWAGE FORM 4-11
8	336570	1	MUFFLER
9	336560	1	REED VALVE
10	336580	1	MUFFLER COVER
11	019283	1	COMBUSTION CHAMBER SPRING GUIDE
12	013737	1	INJECTION PIPE ASSEMBLY
14	019276	2	COMBUSTION CHAMBER SPRING GUIDE
15	013738	1	BRACKET FUEL LINE
16	900595	1	SCREW SWAGE FORM 4-9
17	019819	2	SCREW TORX 25 M5-12
18	019277	1	NOSE
19	019289	1	COMBUSTION CHAMBER BUMPER ASS.
21	019402	1	UPPER PROBE ASSEMBLY
22	019295	1	KNOB
23	019735	1	PROBE AXIS
24	019278	1	PROBE
25	019275	1	CARTER
26	013812	1	ELECTROVALVE HEAT PROTECTION
27	013787	1	NOSE PROTECTION
28	013813	4	SCREW CHC M5-16
29	019121	1	CAP
30	013797	4	SCREW CHC M5-35
31	019077	1	MOTOR ASSEMBLY
32	014771	1	FAN MOTOR GROUND WIRE
33	401355	1	RETAINING RING
34	900470	1	MOTOR MOUNT
35	404702	1	SCREW THREAD FORMING 6X3/8
36	013808	1	WIRES GUIDE
37	013731	1	SPARK PLUG ASSEMBLY
38	321590	1	MOTOR SLEEVE
39	013740	1	CYLINDER HEAD
40	321650	1	CYLINDER O'RING
41	321660	1	FAN BLADE ASSEMBLY
42	013750	1	SEAL
43	900969	4	SCREW SWAGE FORM 4-15
44	019288	1	COMBUSTION CHAMBER ASSEMBLY
45	013781	2	COMBUSTION CHAMBER STOP PIN
46	019073	1	COMBUSTION CHAMBER LOCK OUT
47	013805	2	SCREW TAP TYPE 4X8
48	015000	2	CARTER LABEL
49	019291	1	MAGAZINE ASSEMBLY (LEFT & RIGHT)
50	013741	1	SHEAR BLOCK
51	014403	1	NAIL CHANNEL
52	019280	1	COVER PLATE MAGAZINE
53	019387	2	NAME TOOL LABEL
54	013767	1	MAGAZINE SPRING
55	019279	1	FOLLOWER ASSEMBLY
56	013762	1	FOLLOWER SUB ASSEMBLY
57	014999	1	LEVELS LABEL
58	019297	1	HANDLES ASSEMBLY (LEFT & RIGHT)
59	019386	1	NAME PLATE LABEL
60	013799	4	SCREW ECO-SYN TORX 4X25
61	019089	1	POWER BUTTON
62	019091	1	DEL ASSEMBLY
63	019273	1	BATTERY TERMINAL ASSEMBLY
64	019286	1	WIRES ASSEMBLY
65	019119	1	TRIGGER
66	013783	1	TRIGGER SPRING
67	019084	1	COMBUSTION CHAMBER LOCK BAR
68	019096	1	RED S-MEFI
68-1	019097	1	BLACK S-MEFI
69	013734	1	CONTACT LEVEL
70	013785	1	CONTACTOR PLATE
71	013798	9	SCREW ECO-SYN TORX 4X12
72	019290	1	HOOK SPRING ASSEMBLY
73	019284	1	HOOK
74	019293	1	LOCK MAGAZINE SYSTEM
75	019285	1	SPRING LOCK MAGAZINE SYSTEM
76	013739	1	ELECTROVALVE PLUG CONNECTION
77	019116	1	RED ELECTROVALVE ASSEMBLY
77-1	019117	1	BLACK ELECTROVALVE ASSEMBLY
78	019088	1	EJECT BUTTON ASSEMBLY
79	019282	1	ANTENNA
80	019281	1	HANDLE COVER

TORQUE VALUES	
MIN	N.m
MAX	

■ Apply Loctite RC-620 (Green) - ▲ Apply Loctite 243 (Blue)